



INGENIUM CO.,LTD

COMPANY PROFILE

PROFESSIONAL INSTALLATION SERVICE



BUSINESS PROFILE.

Company Name	. Ingenium Co.,Ltd
Business Trade Name	. Engineering and Trading Company
Date Established	. March 2015
Tax ID	. 0-1255-58007-26-4
Business Address (Head Office)	. 25/38 Moo 4 T.Bang Phai A.Muang Nonthaburi,11000 Thailand
Business Address (Factory)	. 37/22 Moo 6 Lat Lum Kaeo, Lat Lum Kaeo District, Pathum Thani 12140 Thailand
Contact Numbers	. Tel/Fax . 02-117-4619
Register Capacity	. THB 10,000,000
Employee	. 37 Person (Full time employee)
Email	. itti@ingenium.co.th
Web Site	. www.ingenium.co.th



ABOUT US.

Ingenium Co.,Ltd was established since March 2015. We have experience and expertise in bulk solids material handling system and provide LEAN production solutions within various industries. We focus on the complete production process from bulk material handling system, Industrial Sieving and Screening Equipment, High-end Rotary Valves and Diverter Valve, Plastic extrusion System, Pneumatic conveying system, IBC System and production intermittent processes including movement and lifting of goods.

We cover engineering design, manufacturing for stainless and mild steel work, Professional installation service, Commissioning start-up services, and after-sales services.

Ingenium Co.,Ltd projects today range in scope from equipment and accessory sales to complete design and installation of turnkey systems. Our goal is to create a long and successful relationship with our customers to help them achieve improvement of product quality, increase production efficiency and improve labor operations.

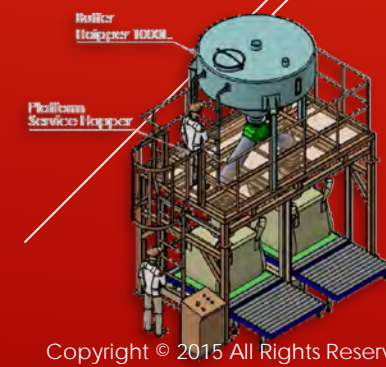
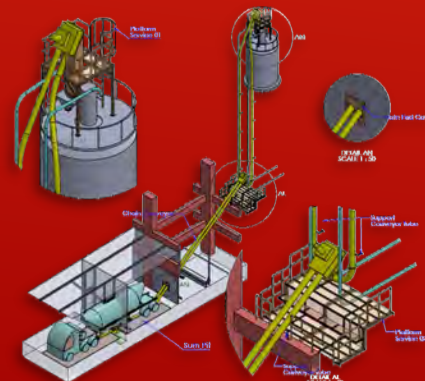
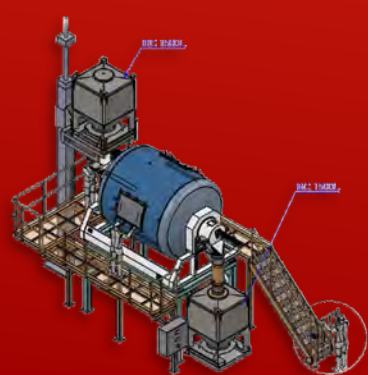

WHAT WE DO.

- **Process Improvement Consulting Services .**
Helps customers analyze their current production processes, discover improvement, consultancy
- **Engineering Design .**
3D process concept design & Combine the Any Equipment Drawing into the Factory Layout.
- **Bulk Material Handling Components .**
Process Equipment and Component for Bulk Material Handling.
- **Structural Steel Fabrication .**
Stainless/ Mild Steel Fabrications, Such as Silo, Hopper, Tank, Piping Structural Framework.
- **Installation Service .**
Provide Professional Installation Service for Bulk Material Handling System and Other System
- **Electrical and Control .**
Provide PLC & Operation Interface Programming for. AB, Siemens, Omron, Mitsubishi and etc. & Service.
- **Loading and Unloading Labor Services .**
Un-loading, Un-Packing, Move the Equipment to Position.
- **After Sales/Service and Support**
24 hours a day, 7 days a week, 365 days a year. Our skilled technicians can help you.
- **Manpower Supply Services .**
We also provide manpower supply services for installation works and assistance to commissioning towards start-up.



ORGANIZATION.



Professional Installation Services





SAFETY FIRST...NO COMPROMISE.

IN-HOUSE SAFETY TRAINING (IG SAFETY DAY)

หลักสูตร การฝึกอบรม

การติดตั้งและตรวจสอบนั่งร้าน

Installation & Inspection Scaffolding



มาตรฐาน BS EN12811-1, Frame Scaffold

ศูนย์ฝึกอบรม พี.อาร์.เค.เซฟตี้เทรนนิ่ง (ประเทศไทย) จำกัด
เลขที่ 79/423 หมู่ 4 ถนน สายกลางคู่ ตำบล นิคมระ อําเภอ ีตัง จังหวัด ระยอง 21150
เบอร์โทร 062-5165653 Email : P.R.K.Safety@gmail.com ID Line : PRKSAFETY



หลักสูตร

ความปลอดภัยในการทำงานบนที่สูง



สมาคมส่งเสริมความปลอดภัยและอนามัยในการทำงาน (ประเทศไทย) ในพระราชูปถัมภ์
สมเด็จพระกนิษฐาธิราชเจ้า กรมสมเด็จพระเทพรัตนราชสุดาฯ สยามบรมราชกุมารี
Safety and Health at Work Promotion Association (Thailand)
22/3 Boromratchonsee Rd., Talinchan Bangkok 10170
Tel 0-2884-1852 ,0-2880-4803,0-2880-4592
Fax 0-2884-1853,0-2880-4591
www.shawpa.or.th E-mail : shawpa1training@gmail.com



SAFETY FIRST... FIVE MINUTES FOR YOUR LIFE



ENGINEERING DESIGN CENTER.

- By 3D and 2D Licensed program



CERTIFICATE.

- Effective Safety Training.
- Basic Vibration, Alignment and Balancing Training.



PROGRESS REPORT

NO	Work plan	Progress	Percentage	Detail
1	Platform for cyclone 3 set install	90%	90%	2 Platform and full cable to install. Remaining 10% for the cable to be installed.
2	Cyclone 3 set install	100%	100%	1. Cable and full cable to install. Remaining 0% for the cable to be installed.
3	Silo 250 assembly & install	100%	100%	1. Cable and full cable to install. Remaining 0% for the cable to be installed.
4	Lot 4 unloading	100%	100%	1. Cable and full cable to install. Remaining 0% for the cable to be installed.
5	Platform & dust collector 4 set install	100%	100%	1. Cable and full cable to install. Remaining 0% for the cable to be installed.
6	Lot 4 unloading	100%	100%	1. Cable and full cable to install. Remaining 0% for the cable to be installed.
7	Multi scale & Silo 250M2-2 install	100%	100%	1. Cable and full cable to install. Remaining 0% for the cable to be installed.
8	Lot 4 unloading	100%	100%	1. Cable and full cable to install. Remaining 0% for the cable to be installed.
9	Platform 12 bucket elevator of granule install	100%	100%	1. Cable and full cable to install. Remaining 0% for the cable to be installed.
10	Support frame of Granule PCC installation & Safety PCC 3 set install	100%	100%	1. Cable and full cable to install. Remaining 0% for the cable to be installed.
11	Platform for silo 120M2 of granule	100%	100%	1. Cable and full cable to install. Remaining 0% for the cable to be installed.
12	Lot 4 unloading	100%	100%	1. Cable and full cable to install. Remaining 0% for the cable to be installed.
13	Platform color water install	100%	100%	1. Cable and full cable to install. Remaining 0% for the cable to be installed.
14	Platform floor install	100%	100%	1. Cable and full cable to install. Remaining 0% for the cable to be installed.

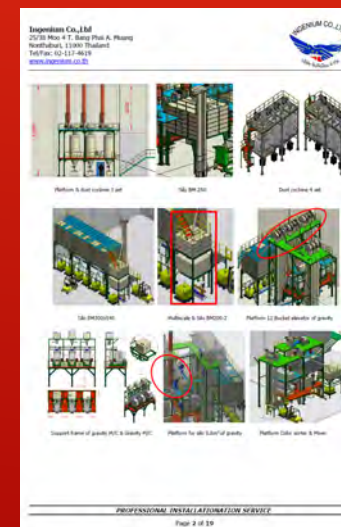

JOB REFERENCE.

3D
Concept Design

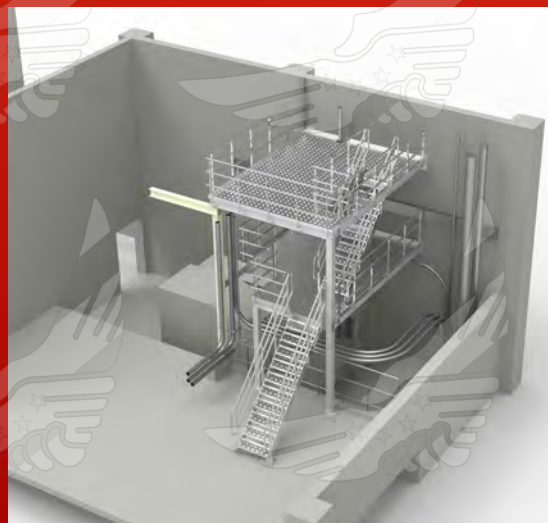
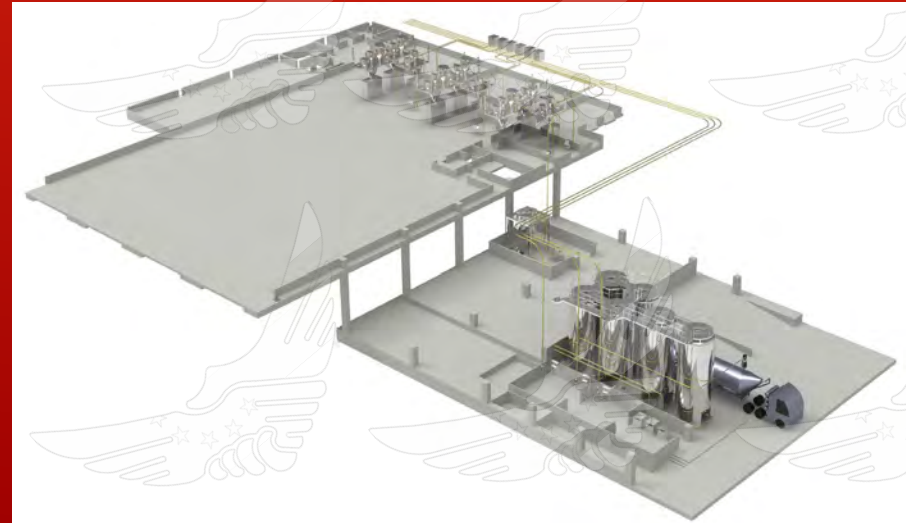
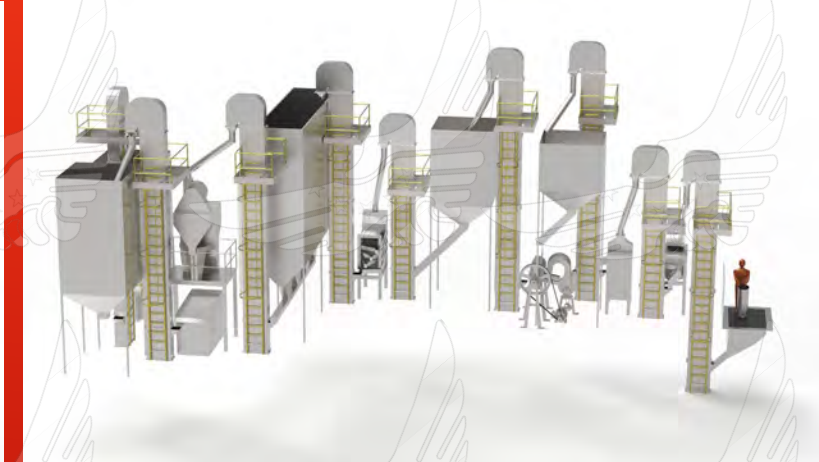
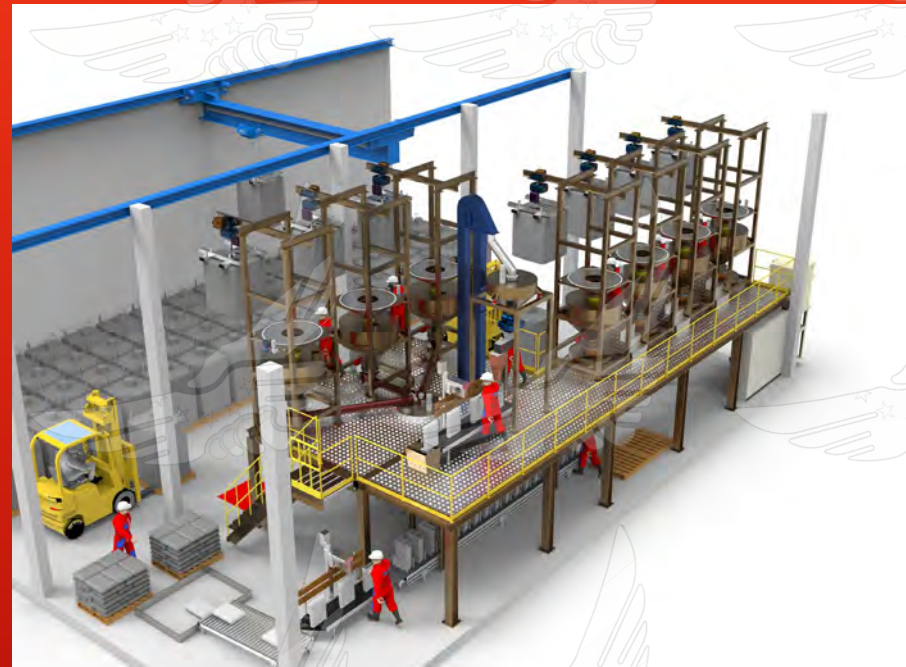

OUR PRODUCT.

Industrial Sieving & Screening Equipment.



farleygreene

ULTRA HYGIENIC ULTRA TOUGH.

Introducing the Easilift Ultra, the latest sack tip screener designed to guarantee your ingredient safety.

SM sievmaster
by farleygreene



Product Specification

Slimline Range

SM 550-FF

Vibratory Check Screener in 550mm Diameter

The 550-FF model can be used as a simple means of check sieving into bins or containers. It is primarily designed to be fed under gravity within new or existing production lines, to screen product into a static weigh bin, big bag, convey line or hopper.

The basic unit will locate within a confined area to provide for retrospective fitting into systems that previously had no sieving equipment. Used with the optional wheeled base assembly, it makes an ideal arrangement to sieve ingredients in small or large batch volumes.



SM sievmaster
by farleygreene



BY INDUSTRIES



Food & Drink



Pharma



Chemical



Nutraceutical



Reclamation & Recycling



Additive Manufacturing



Copyright © 2015 All Rights Reserved. - INGENIUM CO.,LTD

OUR PRODUCT.



High-end Rotary Valves & Diverter.

DMN-WESTINGHOUSE has been designing and manufacturing rotary valves, diverter valves and other related components for the bulk solids handling industry for many years.

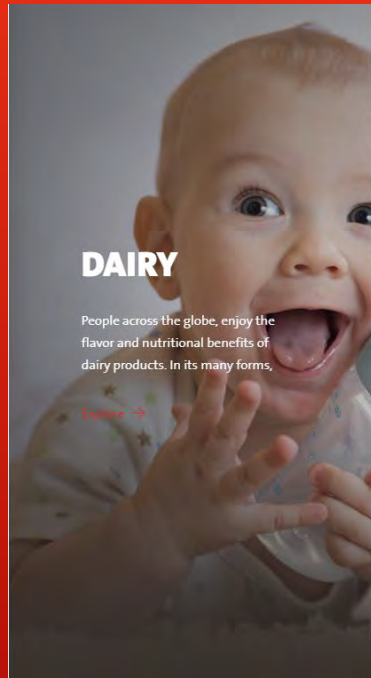

DAIRY

People across the globe, enjoy the flavor and nutritional benefits of dairy products. In its many forms,

[Explore →](#)



FOOD

The food industry is one of the largest on the planet. The World Bank, in figures recently published, valued the

[Explore →](#)



ANIMAL FEED

The food industry continues to grow. According The UN Food and Agricultural Organization, the world

[Explore →](#)

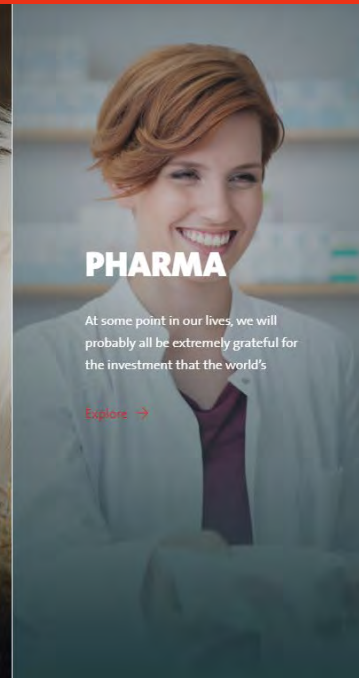

PHARMA

At some point in our lives, we will probably all be extremely grateful for the investment that the world's

[Explore →](#)

Diverter valves by DMN-WESTINGHOUSE come in many types and sizes, suitable for a specific use or a variety of applications. The extensive diverter range comprises a series of plug diverters (dual pipe, single pipe, CIP suitable, gravity) and tube diverters (2-14 ports), some of which are also available in USDA Dairy accepted version. For the mineral industry, the BTD ball type diverter with its rugged design is very suitable for handling abrasive products.



DIVERTER VALVES



ROTARY VALVES

Our rotary valves and diverters have a well-established reputation for being able to handle all kinds of dry powders and granular materials, such as sugar, cocoa, starch, flour, chemical ingredients, lime powder, china clay, fly ash and wood chips. A number of standard rotary valves can be upgraded, depending on the product handled. The housing can be made from Ni-hard casting when working with abrasive products, such as fly ash. Or the inside of the housing can be coated with chromium or tungsten when working with mild abrasive products. What's more, the valve can be fitted with a special rotor when processing sticky products or starch, for example.



CHEMICALS

A world with no processed chemicals at all would present a very inhospitable environment. No

[Explore →](#)

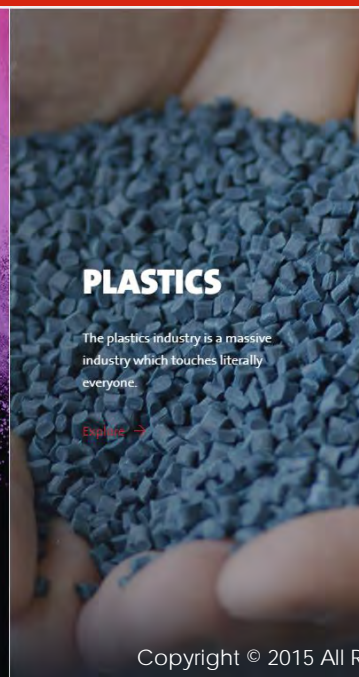

PLASTICS

The plastics industry is a massive industry which touches literally everyone.

[Explore →](#)

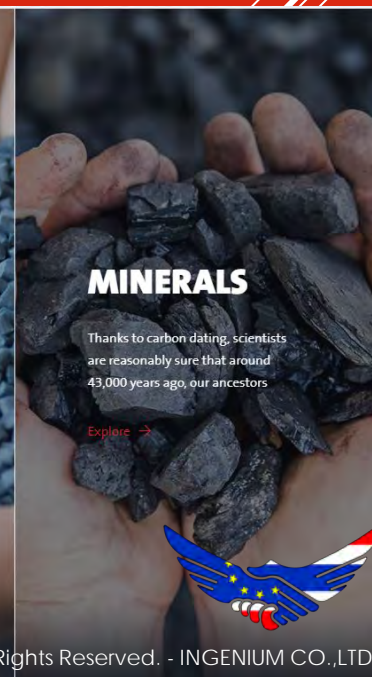

MINERALS

Thanks to carbon dating, scientists are reasonably sure that around 43,000 years ago, our ancestors

[Explore →](#)



OUR PRODUCT.

High-end Rotary Valves & Diverter.



SERVICE & MAINTENANCE

24/7 SUPPORT

DMN-WESTINGHOUSE provides preventive maintenance, for example when it comes to fine-tuning rotor blades and determining tolerances, etc. →



What does this mean for you as a customer?

- ✓ Annual inspection and maintenance
- ✓ 24/7 service, 365 days a year
- ✓ Serviceman within 24 hours on site in case of a defect
- ✓ Advise on increasing the maintenance interval
- ✓ Smaller chance of a production standstill due to breakdowns
- ✓ Also possible with delivery through a retailer
- ✓ Under conditions possible in retroaction





WE ARE OPEN
Now

S.W.L 300 KG

DMN WESTINGHOUSE CERTIFIED SERVICE PARTNER



ROTARY VALVES AND DIVERter VALVES



AFTER SALES / SERVICE AND SUPPORT

24 HOURS A DAY, 7 DAYS A WEEK, 365 DAYS A YEAR. OUR SKILLED TECHNICIANS CAN HELP YOU.



QUALIFIED, VERIFIED, CERTIFIED!



OUR PRODUCT.

BRAMBATI

S.p.A.

Brambati specialises in coffee production plants and similar types.

We can supply "turnkey" plants, from the reception of green coffee up to feeding packaging machines, through cleaning, storage, weighing, blending, roasting, conveyance (with either traditional mechanical conveyors or the latest generation of slow conveyors), grinding and degassing.

Our roasters come in a variety of sizes, from 5-7.5Kg/batch (20Kg/h.) to 600Kg/batch (3000Kg/h.). They can be the traditional type (KAR or KAR-S models) or with highly automated design (BR models), allowing for complete flexibility in controlling the coffee roasting process, by adapting the roasting features to the different Customer requirements.



OUR PRODUCT.



- 100% dust tight seal
- No product build-up, no contamination
- Standard sizes 100-650 mm diameter
- FDA and 3-A hygiene certification
- Ideal for Clean in Place (CIP)
- Certified explosion resistance
- Vacuum resistant



JOB REFERENCE.

Job Design Reference for BFM

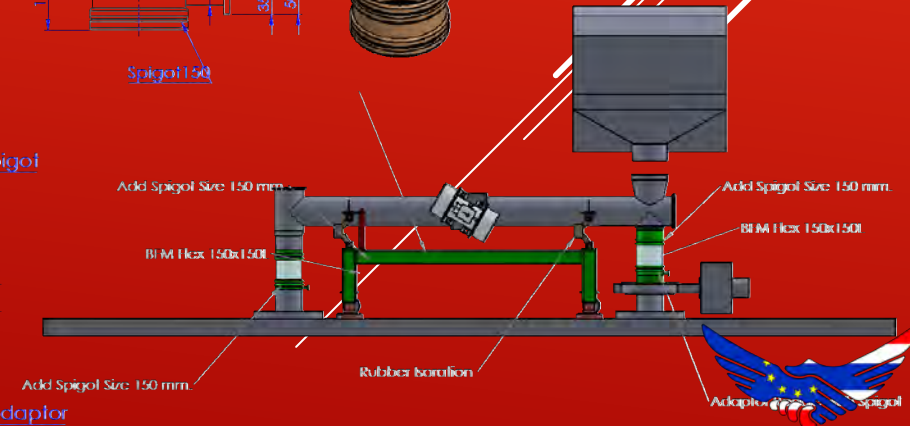
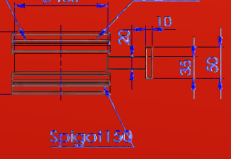
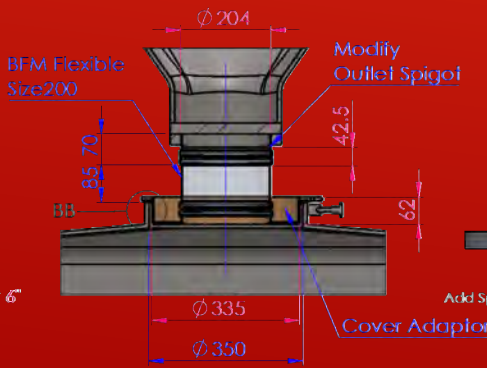
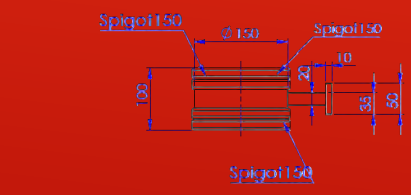
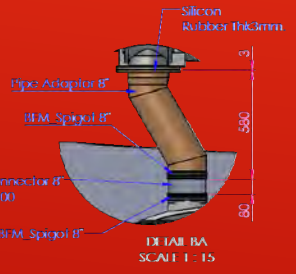
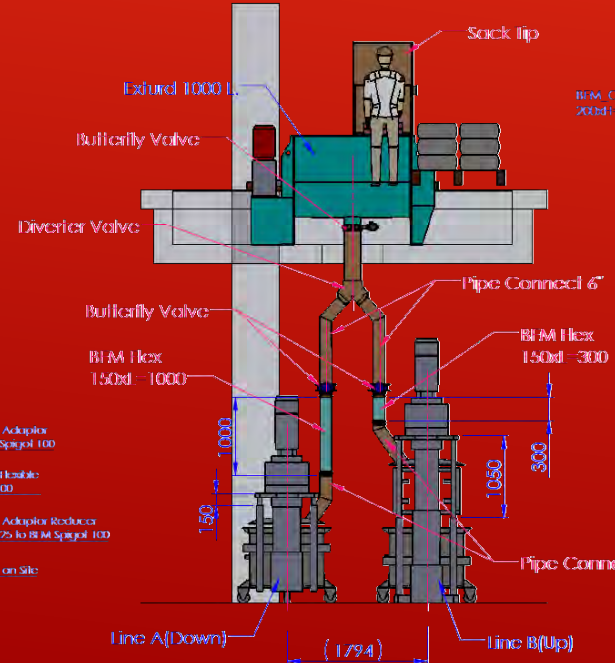
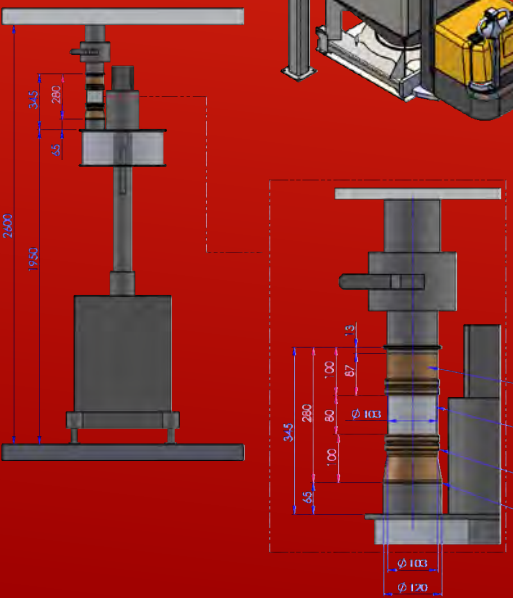
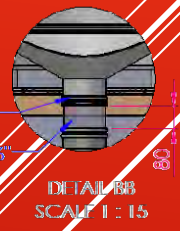
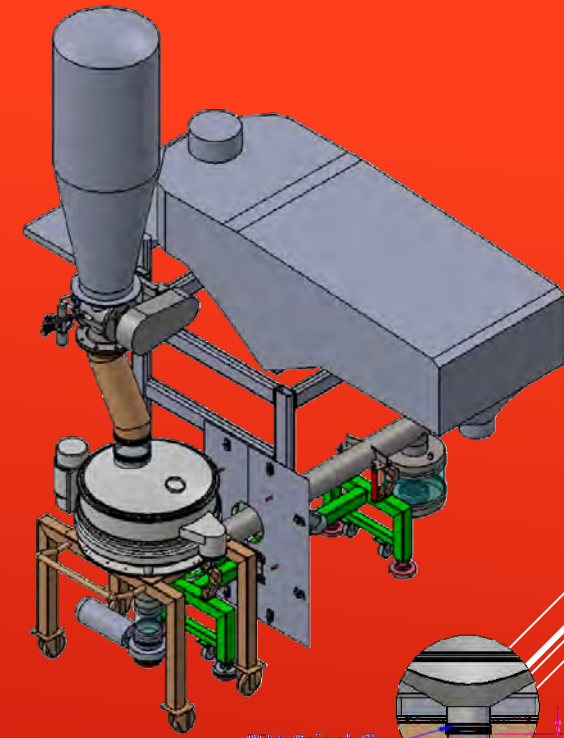
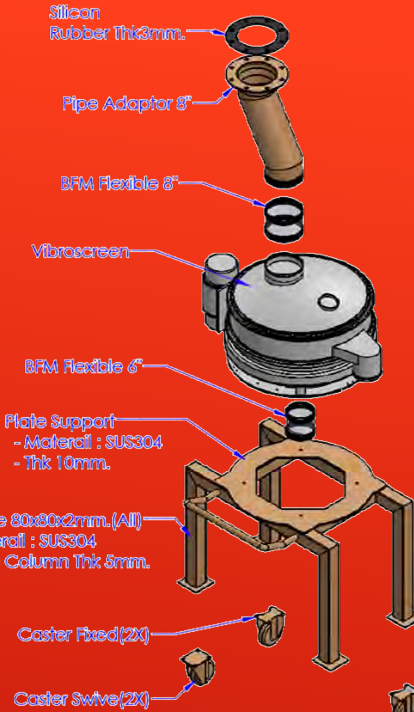
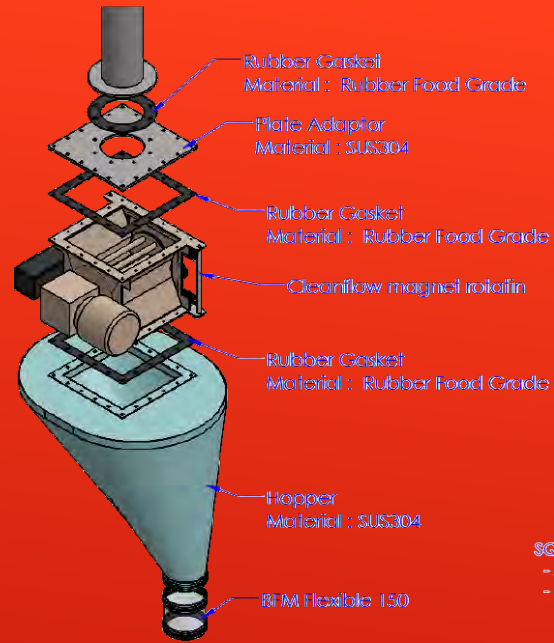
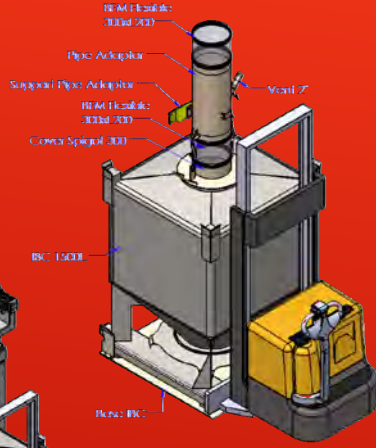
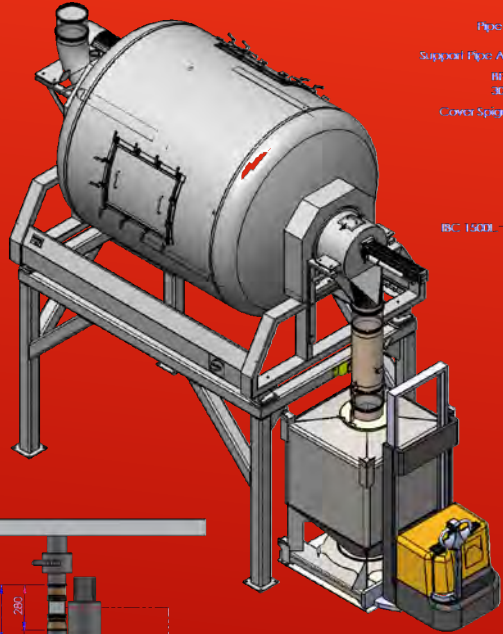

JOB REFERENCE.

Installation Lindor Mixer

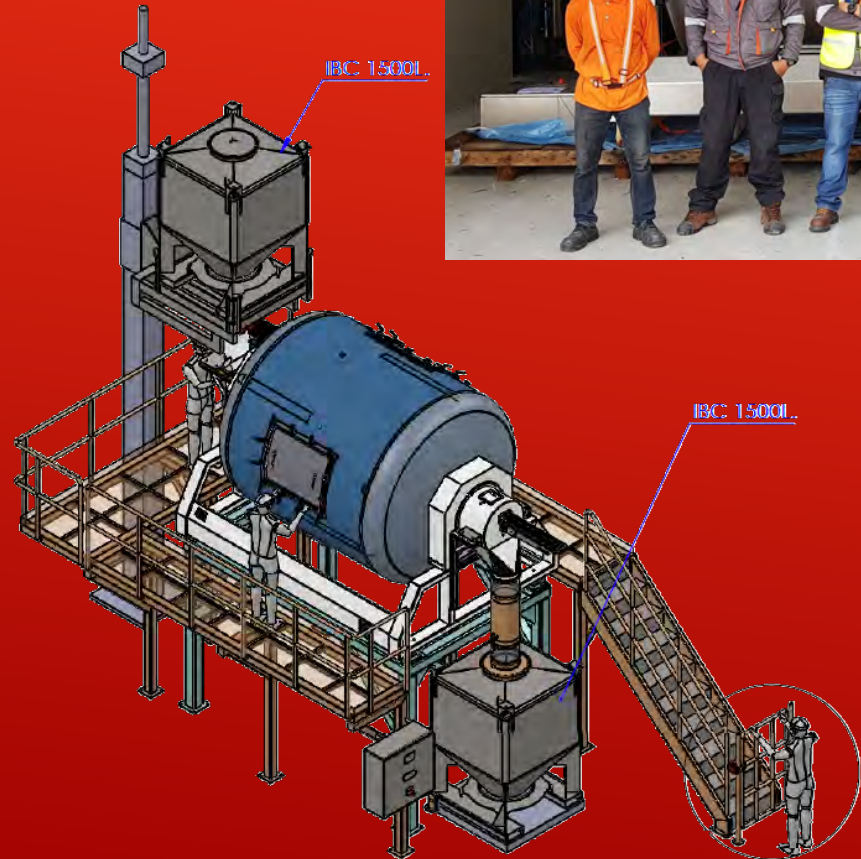

JOB REFERENCE.

Pneumatic Transferring to Storage Hopper and Batching System

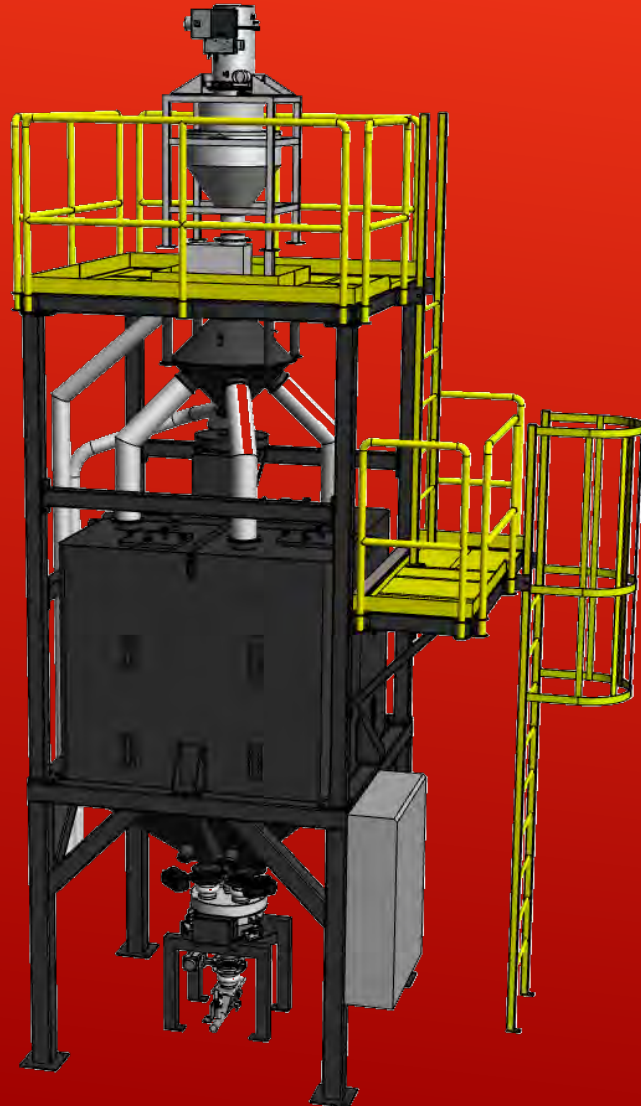

JOB REFERENCE.

Stainless Platform
With Hygienic Design

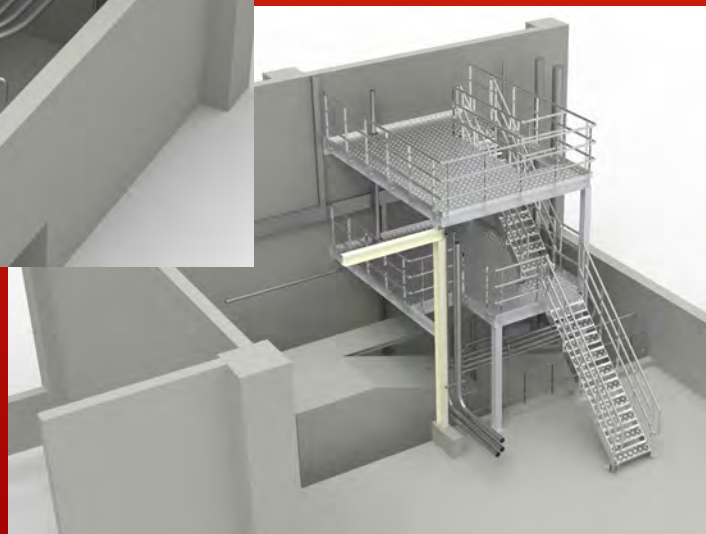

JOB REFERENCE.

Bulk Bag Unloading System

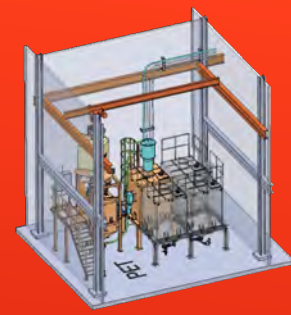

ISOMETRIC VIEW

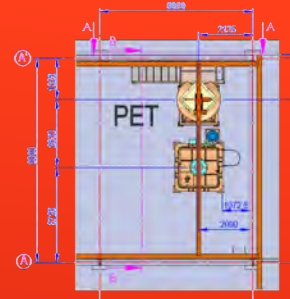

TOP VIEW

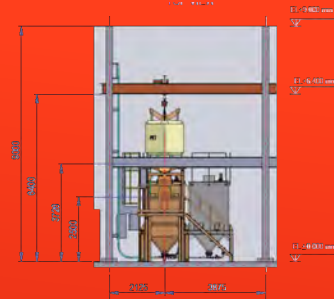

SECTION A-A

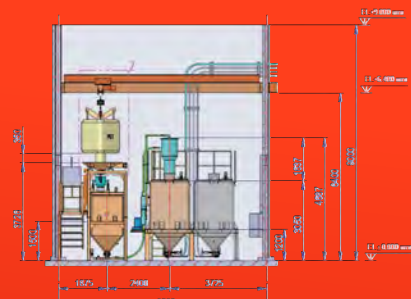

SECTION B-B

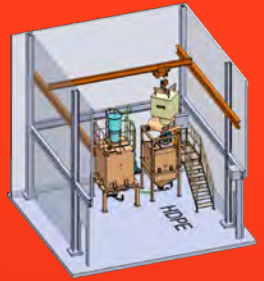

ISOMETRIC VIEW



LINE # A



B # LINE



JOB REFERENCE.

Piping Fabrication and Erection Work

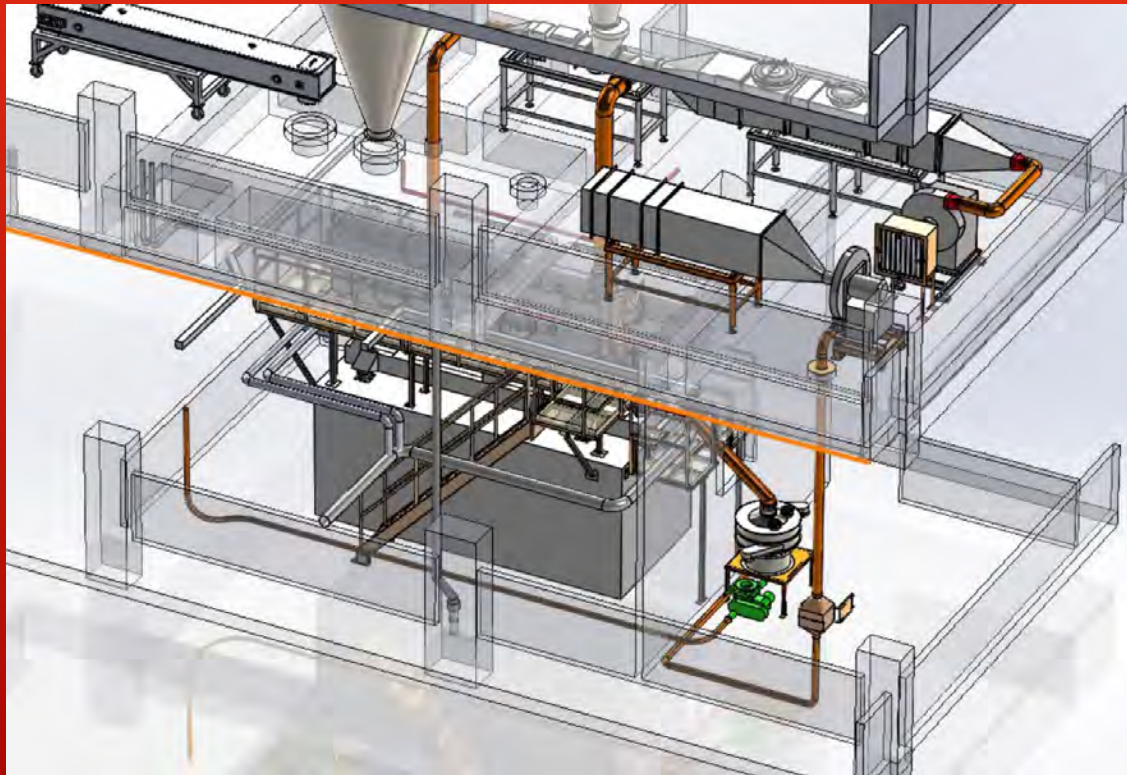

JOB REFERENCE.

Dry Mix – Turnkey Line . 200 Kg / Batch

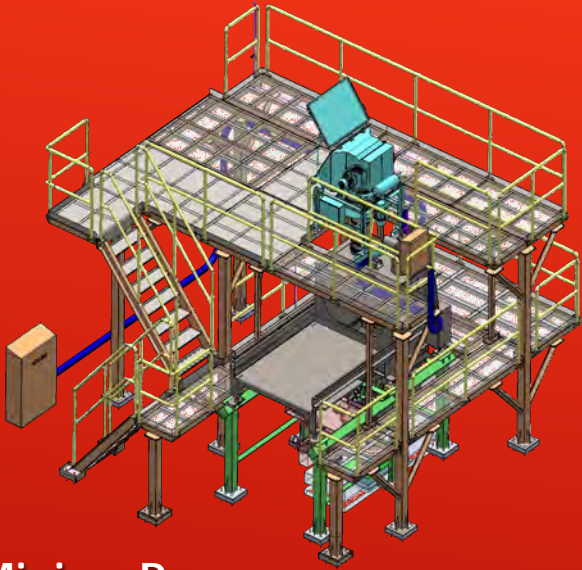

Mixing Process

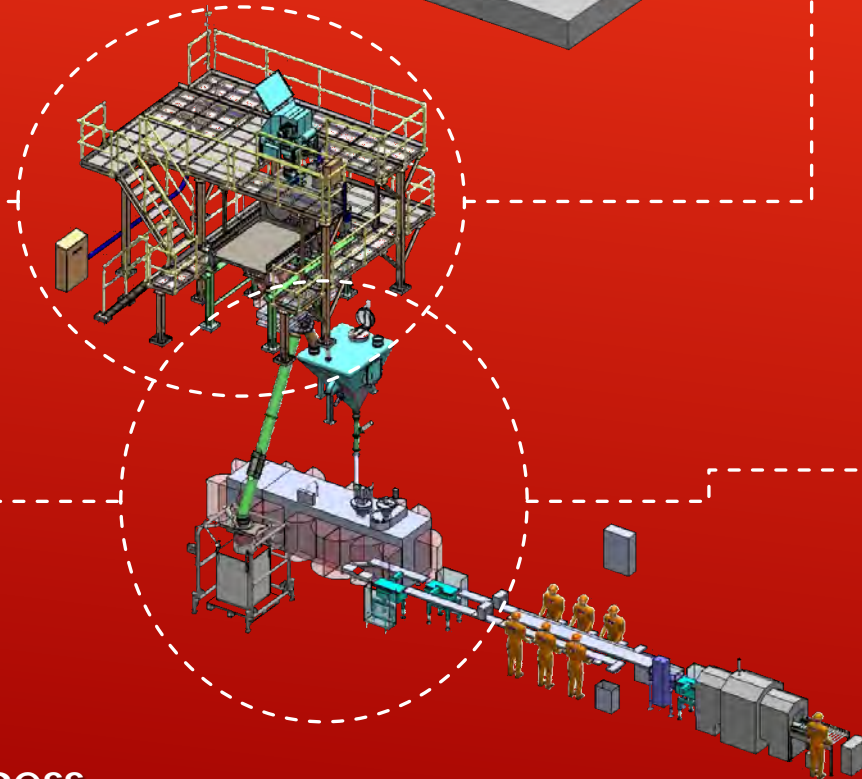
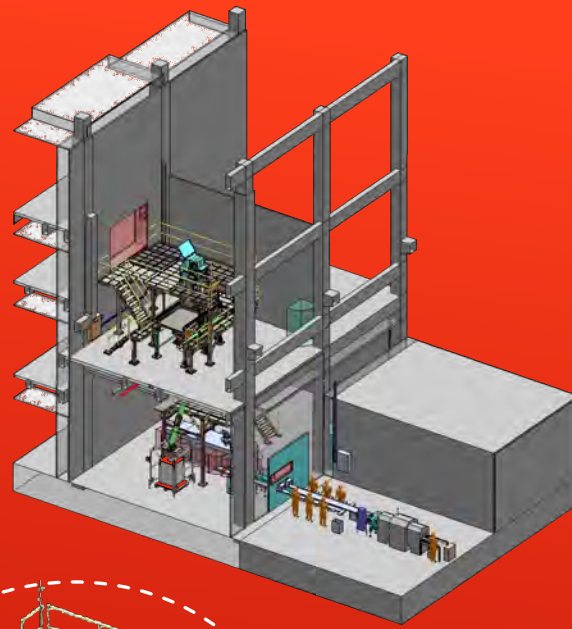

Filling Process



FG
farleygreene

DINNISSEN
PROCESS TECHNOLOGY

DMN
WESTINGHOUSE



Sachet Packing

ISHIDA



JOB REFERENCE.

Installation Job For
Compounding plastic extrusion lines

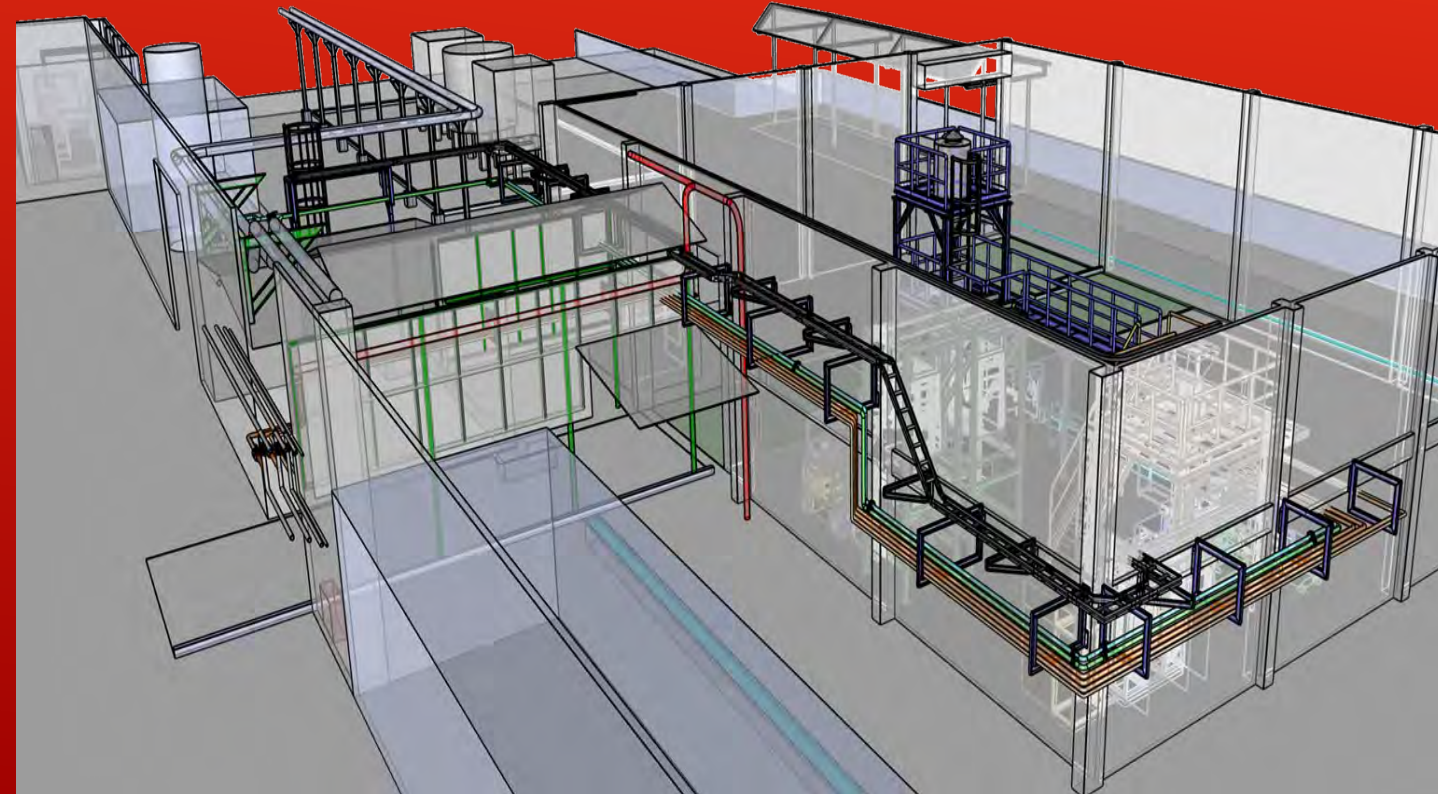
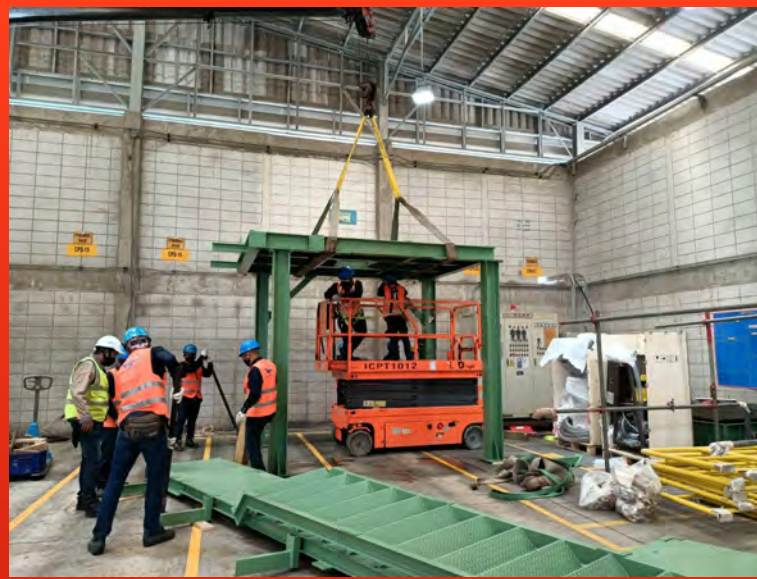

JOB REFERENCE.

Big Bag Unloading Station
with Bucket Elevator Transfer System



SUS304
Platform



JOB REFERENCE.

Big Bag Unloading Station
with Roller Conveyor



JOB REFERENCE.

BRAMBATI

S.p.A.

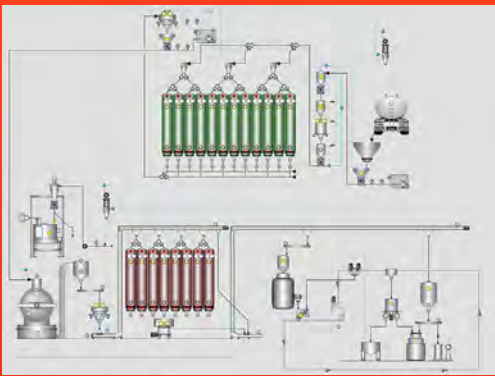

BRAMBATI . Design and Supply Main Equipment
INGENIUM . Supply Local Equipment and Installation work for Coffee Plant

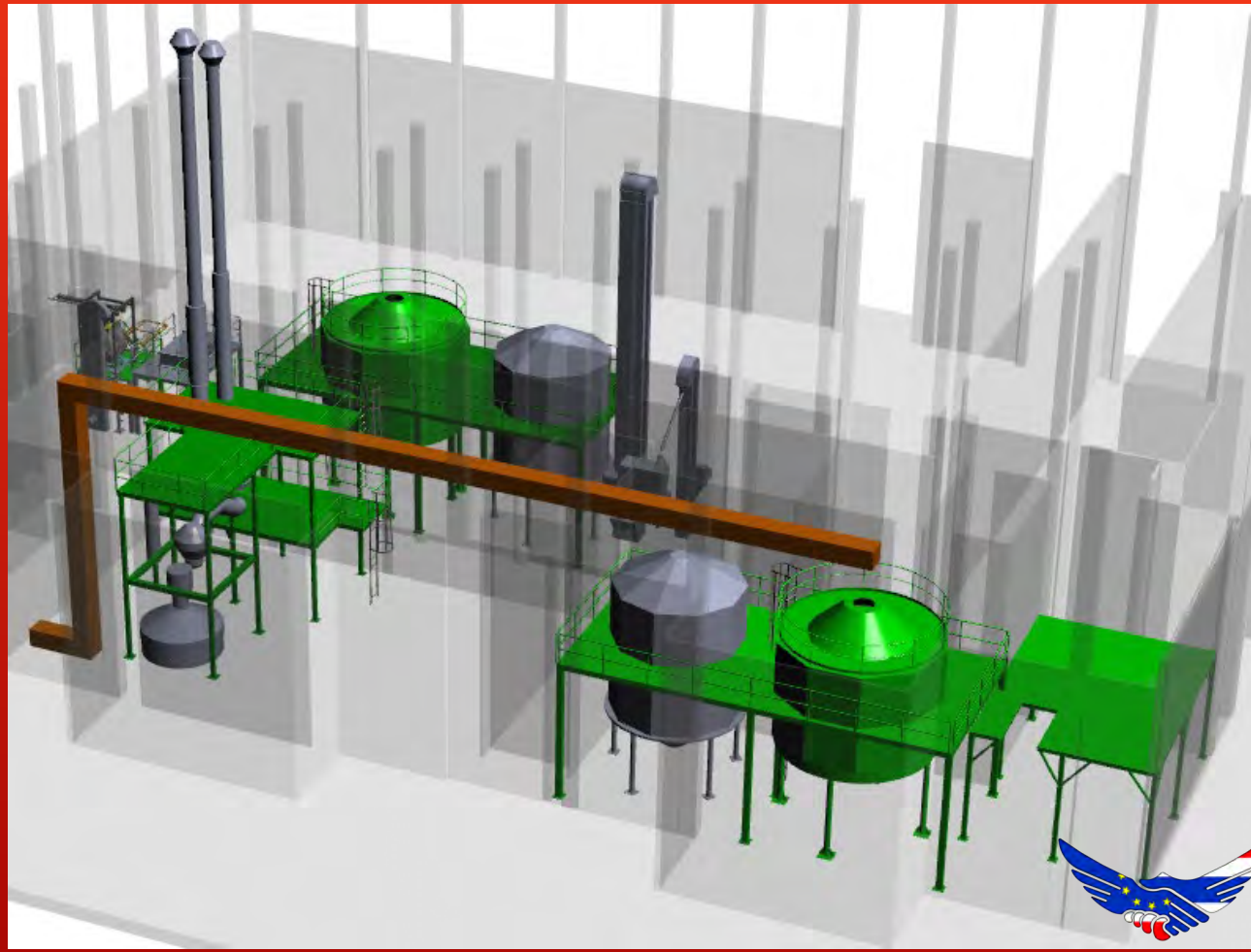

JOB REFERENCE.

Platform and Structure Frame



JOB REFERENCE.

Silo 10 Chamber @ 2 Silo

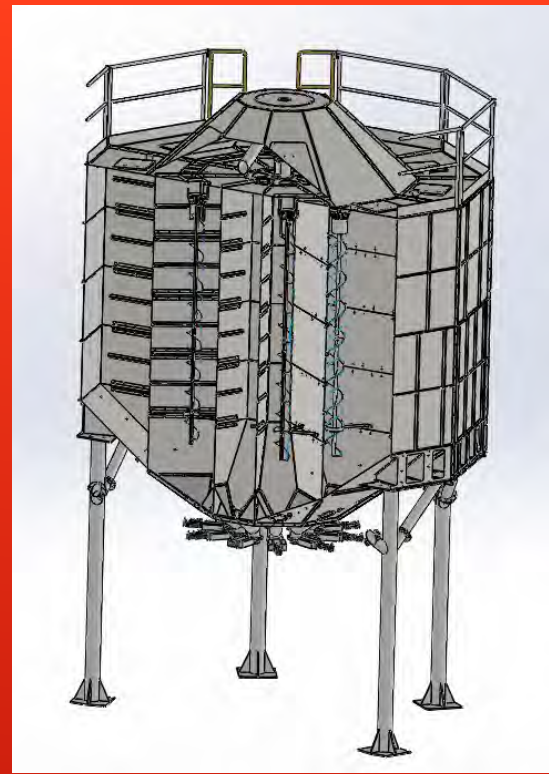

JOB REFERENCE.

Installation Work for ME



Crane 100 Ton



Folk lift and X lift 5-8 Ton

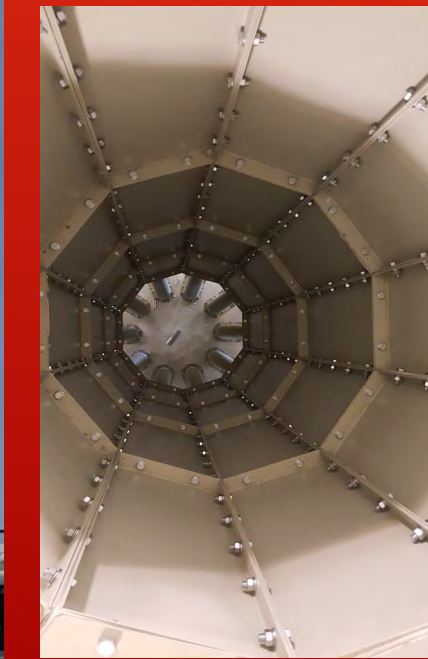

JOB REFERENCE.

Big Bag Station for Bulk Bag

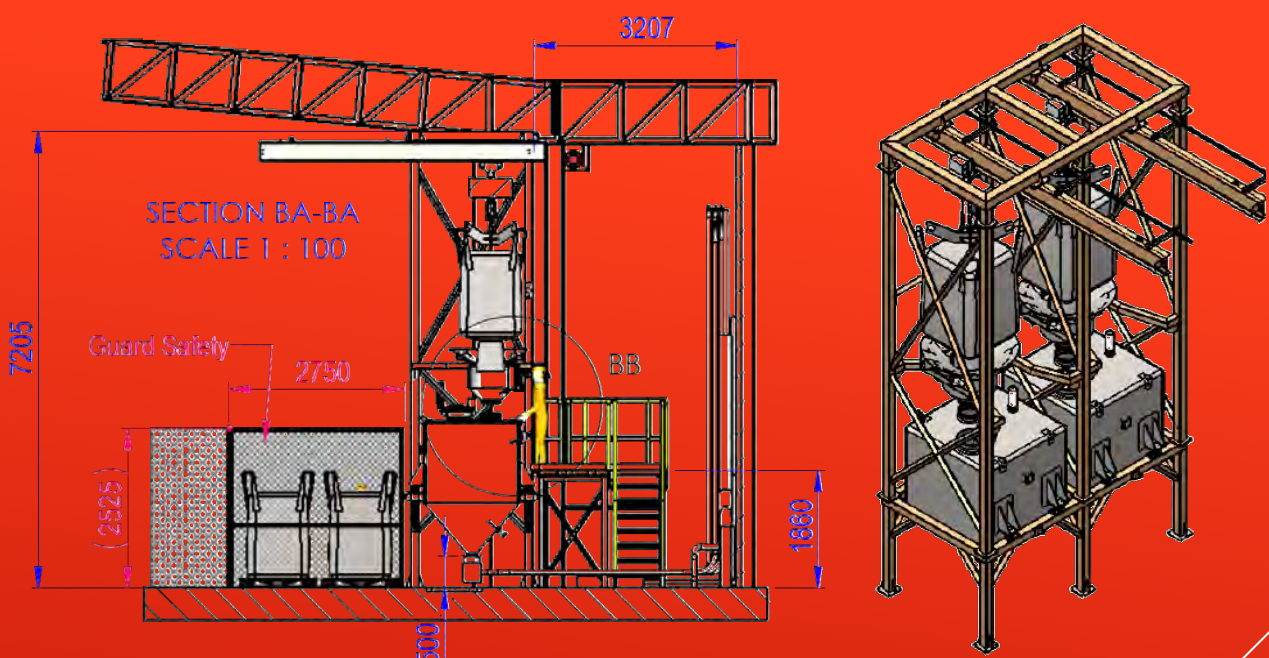
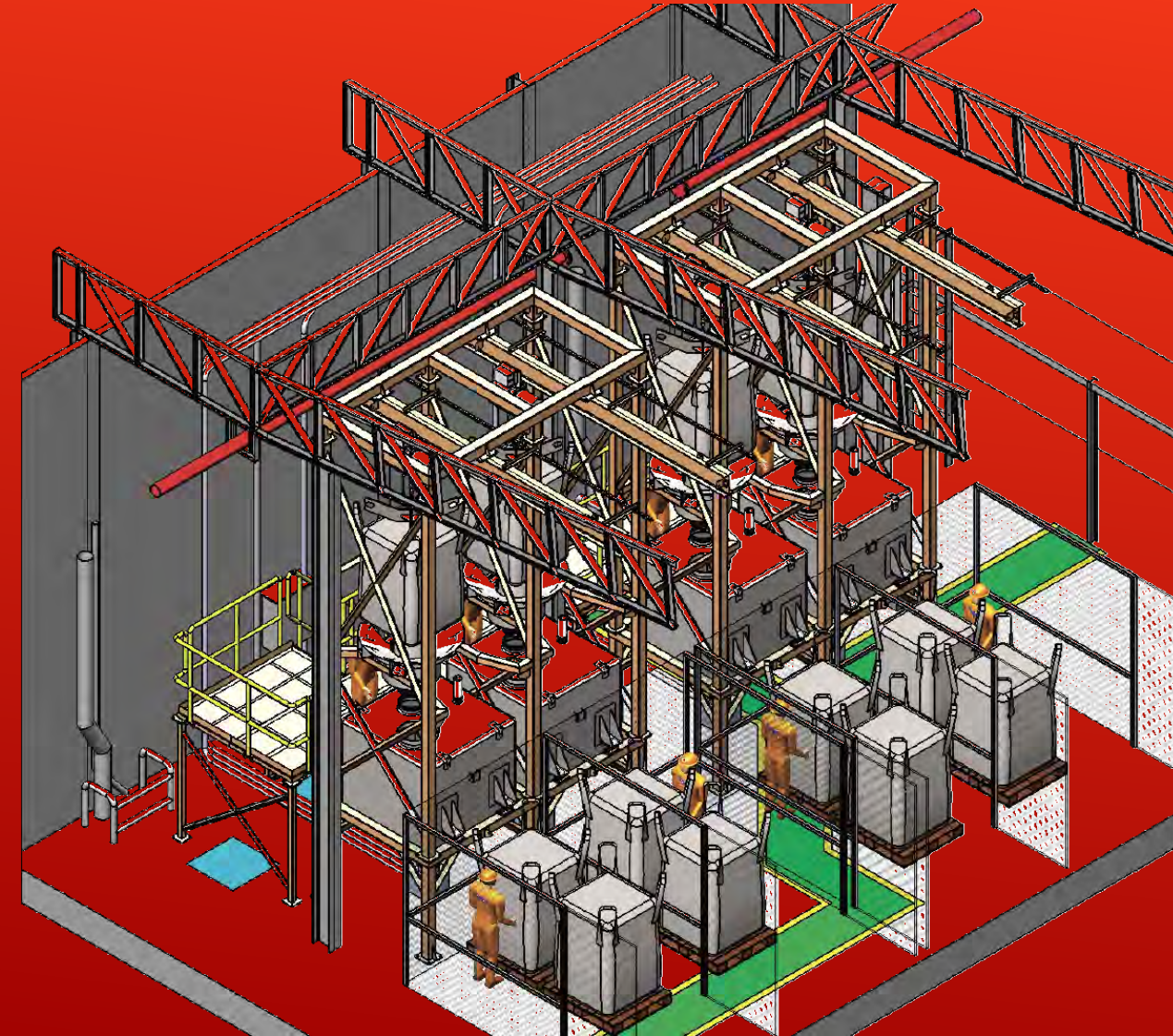

JOB REFERENCE.

Installation Work for ME



Move Silo By Tower Crane



Silo Installation Work



JOB REFERENCE.

Schrage
CONVEYING SYSTEMS

Installation Chain Tube Conveyor for PET Food
(20 Ton / Hr.)

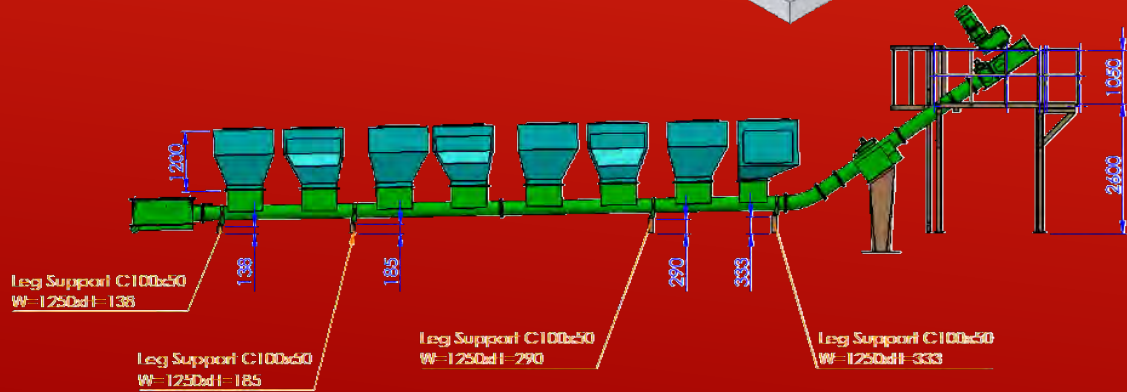
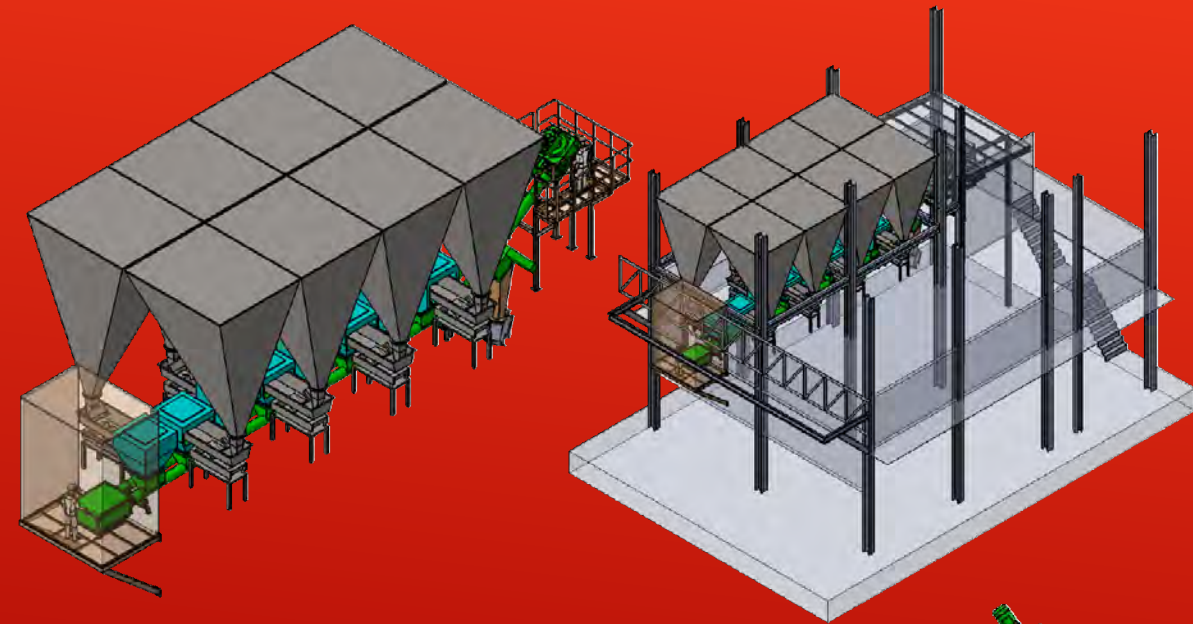

3D Equipment Drawing



Move Existing Equipment out



Up-Packing and Check



Installation Job



JOB REFERENCE.

Schrage
CONVEYING SYSTEMS

Installation Chain Tube Conveyor for PTA Powder (30 Ton / Hr.)



Un loading – Un Packing
&
Installation Work

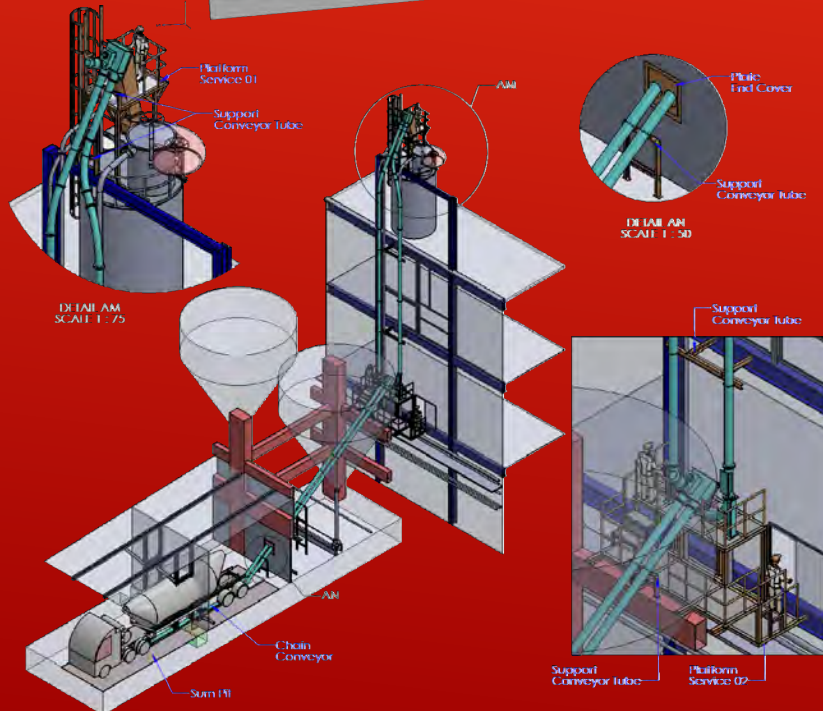
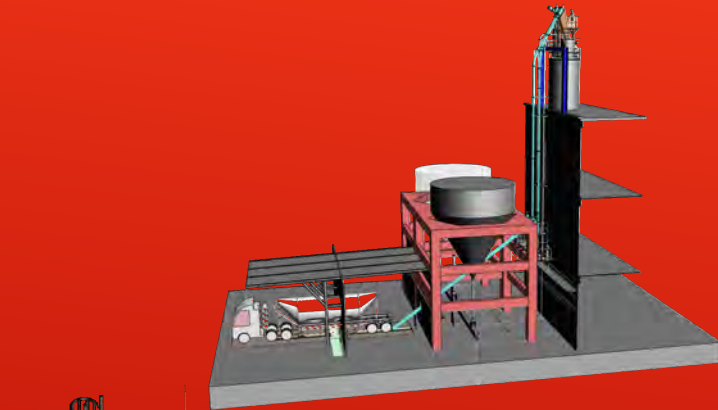

3D Equipment Drawing

JOB REFERENCE.



Installation Chain Tube Conveyor for PTA Powder (35 Ton / Hr.)



Installation Work



Copyright © 2015 All Rights Reserved. - INGENIUM CO.,LTD

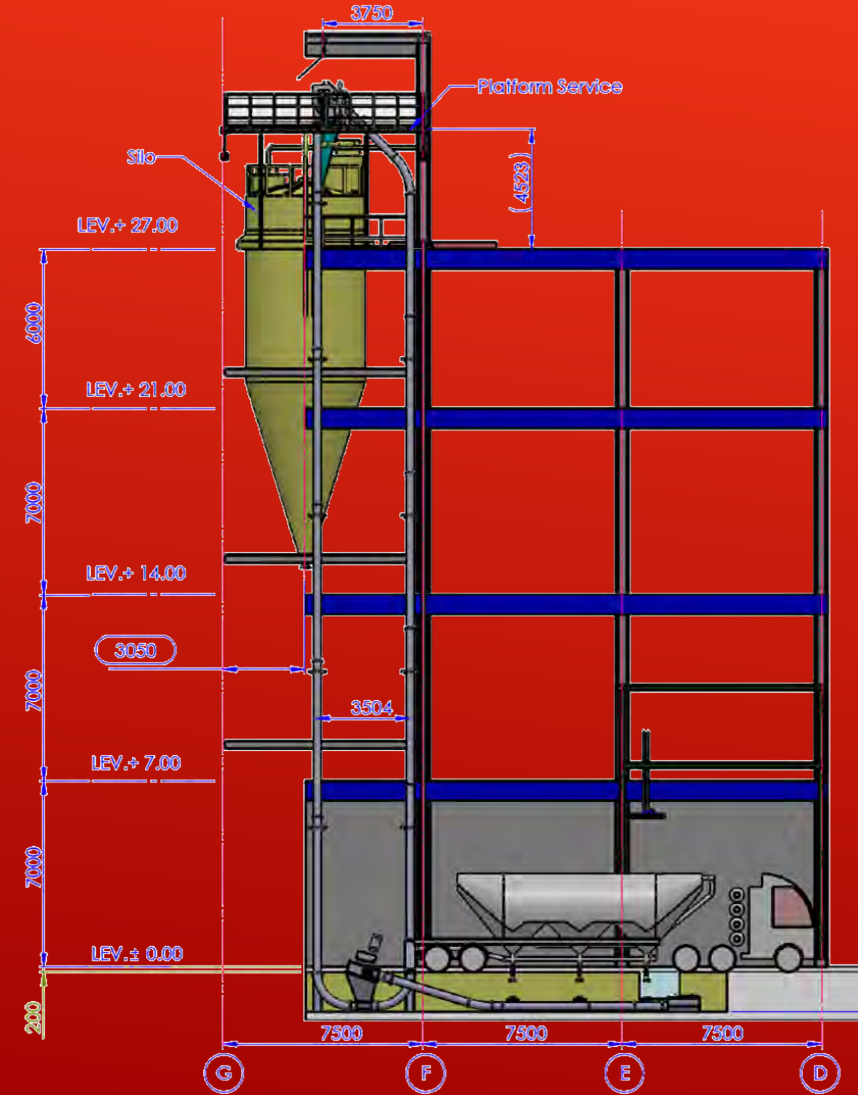

3D Equipment Drawing

JOB REFERENCE.

Big Bag Filler with weight scale.
Batching Control Accuracy \pm . 0.3-0.5%

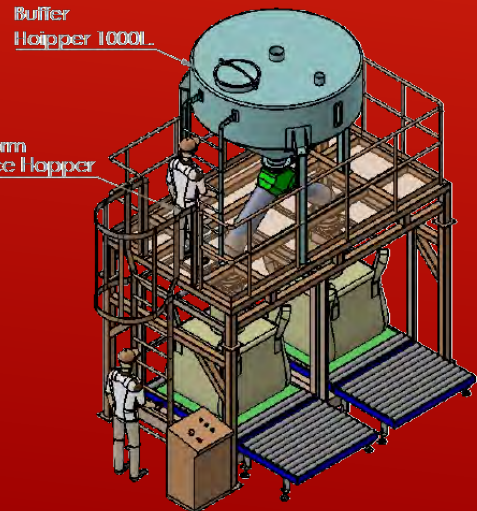
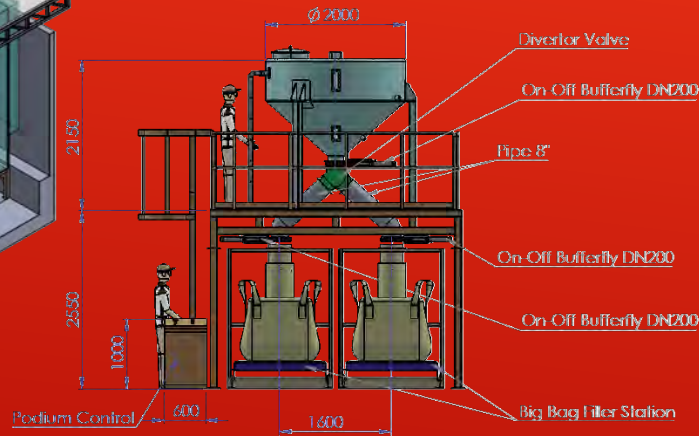
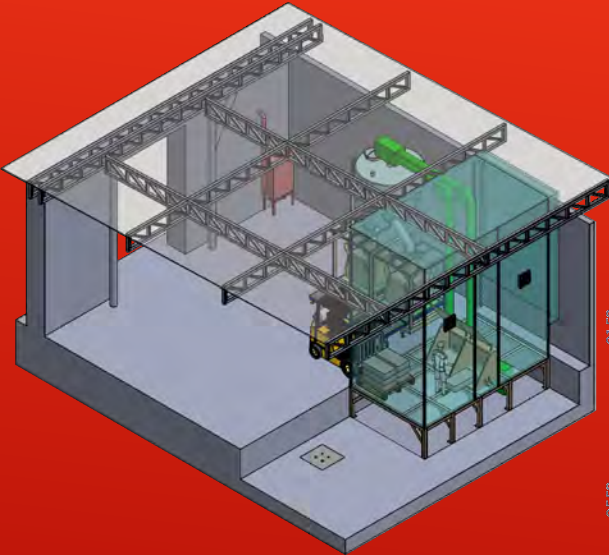

Tipping Station

Installation Job



JOB REFERENCE.

บริษัท เบ้ลท แอนด์ แบร์ริงส์ จำกัด
Belt And Bearings Co., Ltd.

Belt and Bearings Co.,Ltd . Supply Main
Ingenium Co.,Ltd . Support for Installation work.



Un-loading Job



Installation Job

JOB REFERENCE.

Belt and Bearings Co.,Ltd . Supply Main
Ingenium Co.,Ltd . Support for Installation work.



Copyright © 2015 All Rights Reserved. - INGENIUM CO.,LTD



Complete Installation Job



JOB REFERENCE.

Installation for Animal Feed Factory

- Installation Steel Structure Frame for Building.
 - Installation for PET Food Machine 1 Line.
- Complete with.-

- ✓ Raw Material Receiving
- ✓ Batching System
- ✓ Mixing System
- ✓ Grinding System
- ✓ Pulverizer System
- ✓ 2nd Mixing System
- ✓ Extrusion system
- ✓ Drying System
- ✓ Liquid Coating & Cooling System
- ✓ Finish Products System
- ✓ Packaging System
- ✓ Liquid Adding System
- ✓ Electrical Control System



JOB REFERENCE.

Installation for PET Food Factory

- Installation Main Machine for PET Food Machine 5 Line.
Complete with.-

- ✓ Unloading machine to storage area(Over 300 Container)
- ✓ Raw Material Receiving
 - External LIPP Silo Dia 8 m. x H18 m. (1000 m3) @ 2 Unit
 - External LIPP Silo Dia 5.5 m. x H12 m. (350m3) @ 7 Unit
 - External Flat Silo Dia 5.5 m. x H12 m. (350m3) @ 5 Unit
- ✓ All Silo and Dia 2 m. x H12 m. Bin @ 147 Unit
- ✓ All Bucket Elevator
- ✓ Batching System
- ✓ Mixing System
- ✓ Grinding System
- ✓ Pulverizer System
- ✓ Extrusion System
- ✓ Drying System
- ✓ Coating System
- ✓ Finish Products Bin
- ✓ Platform and Support
- ✓ Piping for Pneumatic Transfer



JOB REFERENCE.

Un-loading and Un-Packing



JOB REFERENCE.

Un-loading and Un-Packing



5.2-Ton



5-Ton



JOB REFERENCE.

Our panel are designed and program by people who understand panel, ever to operate the system and maintenance the panel. Since we also support our and other vendors products.



Electrical Drawing



Control With AB PLC



Control With S7-300 PLC

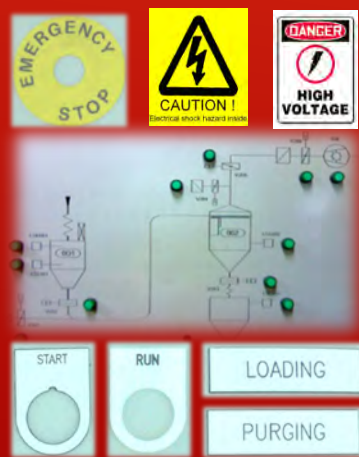

Mimic Diagram & Nameplate



Electrical with Pneumatic Control



Machine Safety Control



JOB REFERENCE.



Main Equipment . Dinnissen Process Technology
Ingenium . Supply Electrical Component and Installation Work

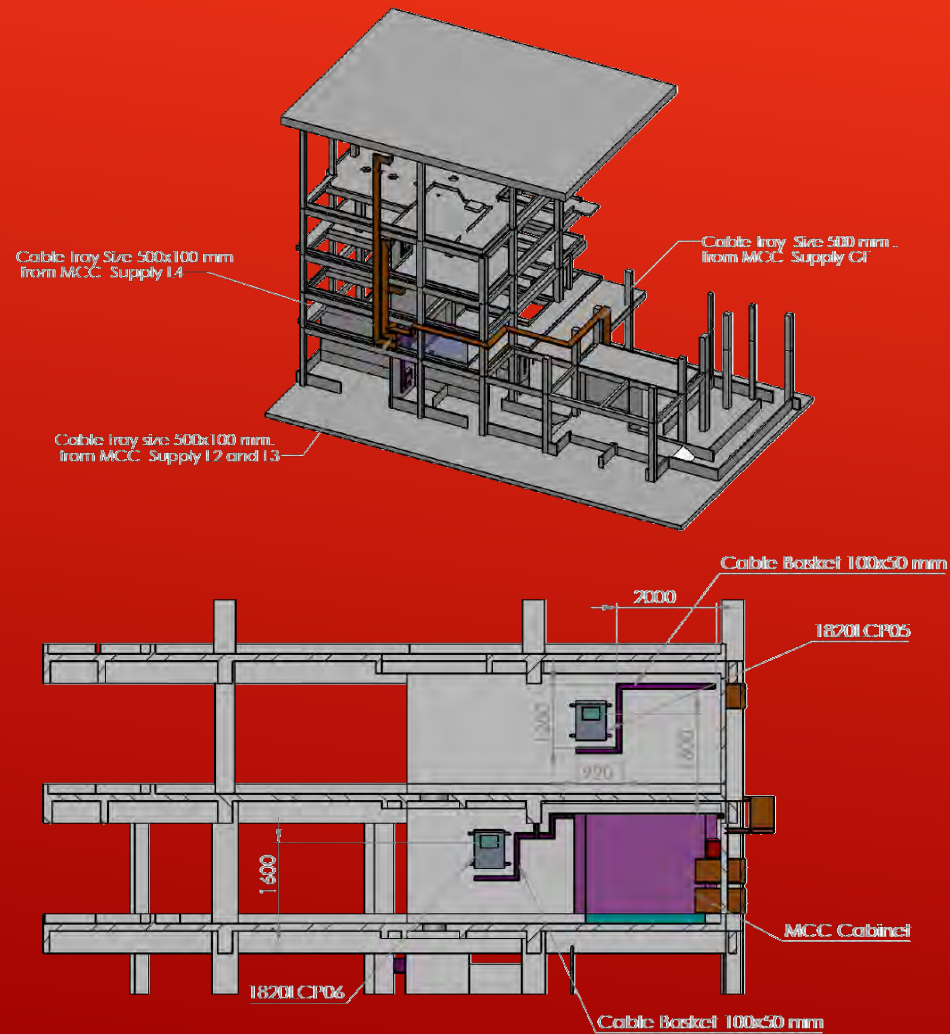

3D Cable Routing Layout Drawing

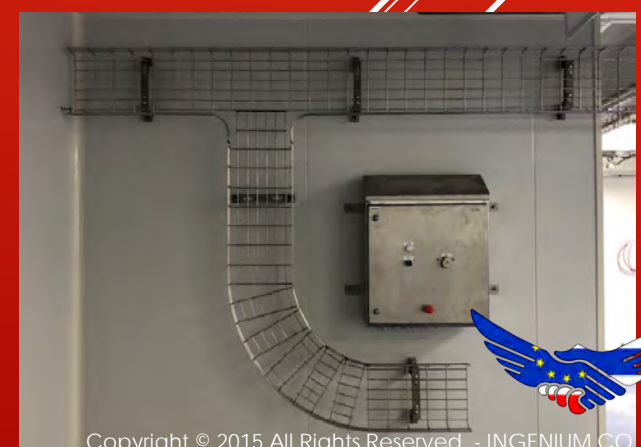



Thank You

